

The Core Family

The Core family line offers a rich diversity of technical and aesthetic options. Our 3" round adjustable offers 14+ finishes & custom wood choices. A wide range of source/optic selections, 3 ranges of Ambient Dim™ (Warm Dim), 5 beam spreads, and a multitude of driver/control options including TruPhase™ (phase dimming down to 0.1%). Our Core product family is created on platform allowing for a high degree of modification.

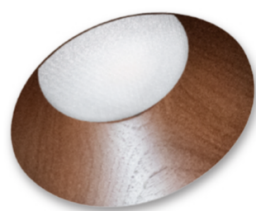
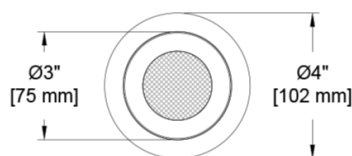
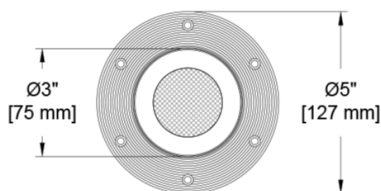

Wood Finish Available

PROJECT:

TYPE:

SPECIFIER:

DATE:

Key Points (CR3D-RA)

Trim

- Flanged or Flangeless
- Flangeless includes plaster flange with lip
- 14 color options + custom RAL or wood available
- One-piece die cast aluminum or machined wood trim

Source / Optics

- 2400K, 2700K, 3000K, 3500K, 4000K Ambient Dim, RGBW & Tunable White options
- 90 CRI, 55+ R9 Standard- 95 CRI 90+R9 Optional
- <2 MacAdam Steps (<2SDCM) for fixed white
- 1780 delivered lumens (Based on 3000K CCT @ 90+ CRI)
- Adjustable to 45° with 360° of rotation
- 5 beamspreads available- 10°, 15°, 24°, 36°, and 50°

Housing

- Heavy gauge steel for new construction or remodel
- Compliant to with Airtight Housing
- Listed – Damp or wet with shower trim
- Approved for 8 (4-in / 4-out) #12 AWG conductors rated for 90°C through wiring
- IC Rated / Airtight Housing approved for use in direct contact with insulation – Chicago Plenum Available

Driver

- TruPhase™ - Dimming down 0.1% - 120V Only
- 0-10, DALI-2, DMX, Lutron or Casambi
- Flicker free to IEEE 1789-2015
- Prewired and integral to housing
- Universal 120-277v

Ordering Codes

PROJECT:

SPECIFIER:

DATE:

TYPE:

QUANTITY:

Ordering Code Example: CR3D-RA-DR-Z-AU-C20-35-24-E2-P14-92A-91L-97L-CP

FIXTURE	APERTURE	TRIM	MOUNTING	SOURCE / WATTS	CCT	BEAM	DRIVER / CONTROL	TRIM FINISH	LENS ACCESSORIES	ACCESSORIES
CR3D-RA										
Core 3" Round Adjustable Downlight	DR Deep Regress	Flangeless Trims Z Flangeless Trim ZS* Flangeless Shower Trim Flanged Trims F Flanged Trim FS* Flanged Shower Trim * Aperture Lens Required	ASPM* ●●● Airtight Shallow Panel IC-Rated ASP ●●● Airtight Shallow Plaster IC-Rated ASU* ●●● Airtight Shallow Universal IC-Rated ●●● Supports CA Title24 compliance	C6* ●●● 6W 364Lm 90+CRI, 60+R9 C8* ●●● 8W 497Lm 90+CRI, 60+R9 C10* ●●● 10W 580Lm 90+CRI, 60+R9 C14 ●●● 15W 1322Lm 90+CRI, 60+R9 C20 ●●● 21W 1700Lm 90+CRI, 60+R9 Tunable T9 10W 90+CRI, 60+R9 Tunable White T15 15W 90+CRI, 60+R9 Tunable White RGBW 90+CRI, 60+R9 Ambient Dim™ A14 ●●● 15W 858Lm 95+CRI, 90+R9 ●●● Supports CA Title 24 Compliance to JA8 except in flat aperture * Only with 10° optic View Photometry	24 2400K 27 2700K 30 3000K 35 3500K 40 4000K Tunable TW1840 1800-4000K Tunable White w/ E1, E2, E3, E4 TW2765 2700-6500K Tunable White w/ E1, E2, E3, E4 RG1280 1200-8000K RGBW Dynamic Color Changing Requires E2 or E4 Ambient Dim™ 2722 2700-2200K 3019 3000-1900K 3022 3000-2200K	10* Narrow Spot * Only with C6, C8, & C10 15 Spot 24 Narrow Flood 36 Flood 50 Wide Flood	C1 0-10 1.0%, UNV (120-277V) linear C2 ELV/Triac 1.0%, (120V) linear E1 0-10 0.1%, UNV (120-277V) log E2 DALI-2 0.1%, UNV (120-277V) log E3 0-10 0.1%, UNV (120-277V) linear E4^ DMX 0.1%, UNV (120-277V) Universal DMX Driver/Controller RGBW-DMX ^ INCLUDES DMX/RDM COMPATIBLE DRIVER WITH BUILT-IN DECODER - CONTROLLER BY OTHERS TR2 TruPhase™ 0.1%, (120-120V) log Up to 20W Forward and Reverse compatible Phase Dimming Static White & Ambient Dim only	W White Paint B Black Paint D Wood* PXX Specialty Paint Color* P01-P15 C Custom/RAL Color** * Wood "D" selection to be used with Z trim and PM mounting - Refer to Wood Trim Guide ** Refer to Finish Guide 	Aperture Lens 91A Solite 93A Frosted XXA Other Aperture Lens Treatments* Reflector (lamp) Media 91L Solite 93L Frosted 97L Black Hexcel Louver XXL Other reflector (lamp) media* 1 piece of media per opening (aperture or reflector) can be selected. *See Lens Accessory Guide 	EM Emergency Pack CP Chicago Plenum Controls ATH Lutron Athena Wireless Node Must be used with E2 driver CA Casambi Wireless BLE to be paired with driver

Ceiling Cutouts and Dimensions

For Deep Regress

Round Flangeless Housing

Panel Mount (PM/APM)

CR3D-RA-Z-PM/APM-

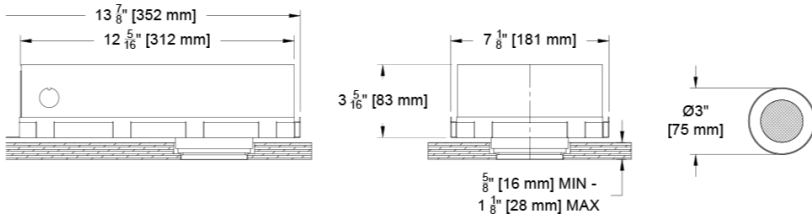

Panel Mount Detail

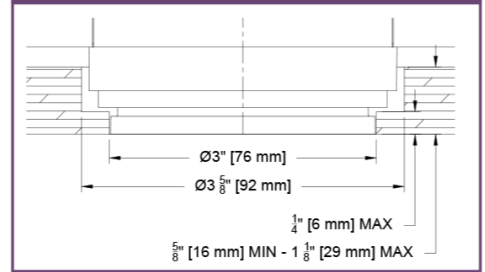

Round Flangeless Housing

Plaster Mount (P/AP)

CR3D-RA-Z-P/AP-

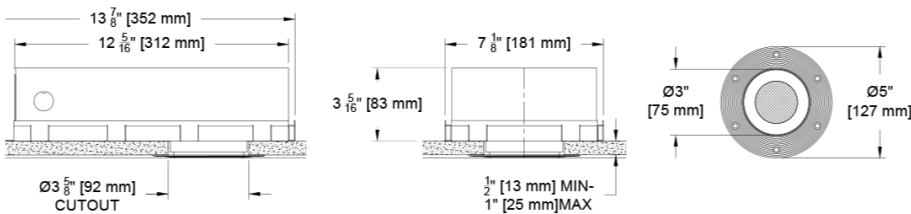

Hanger Bar Detail

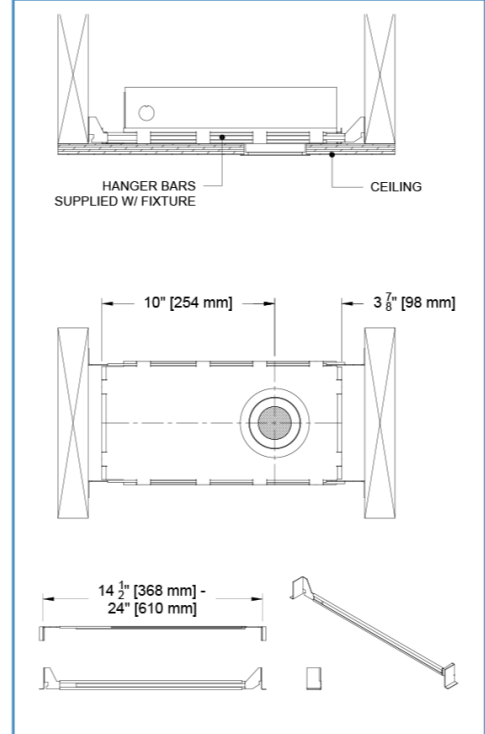

Round Flanged Housing

Universal Mount (U/AU)

CR3D-RA-F-U/AU-

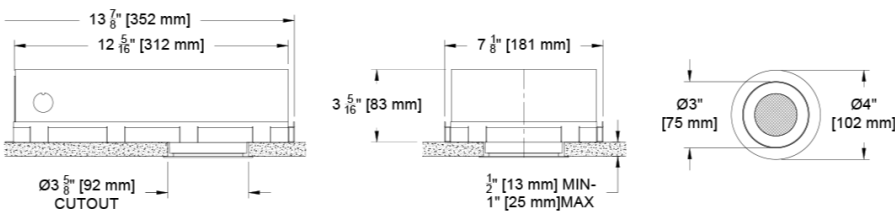

Photometric Table

All data is based from goniometer measurements of production representative product. All lumen values can vary +/- 10% from LED manufacturer rated flux range. Measurements at 3000 CCT

	System watts (W)	10°				15°				24°				36°				50°					
		Del. Lms	Lms/Watt	Peak CD	10% Field	Del. Lms	Lms/Watt	Peak CD	10% Field	Del. Lms	Lms/Watt	Peak CD	10% Field	Del. Lms	Lms/Watt	Peak CD	10% Field	Del. Lms	Lms/Watt	Peak CD	10% Field		
Citizen C6	6	364	63	8827	18°	Not Compatible				Not Compatible				Not Compatible				Not Compatible					
Citizen C8	8	497	60	12052	18°																		
Citizen C10	10	580	54	14056	18°																		
Citizen C14	15	Not Compatible				1233	80	13269	28°	1322	84	6897	40°	1272	84	3980	52°	1290	84	2274	66°		
Citizen C20	20					1626	75	18018	28°	1758	81	9351	40°	1720	79	5385	52°	1730	79	3070	66°		
Ambient Dim A14 - 3019	15					IN PROCESS																	
Ambient Dim A14 - 2722	15																						
Ambient Dim A14 - 3022	15																						
Tunable White - T9	12																						
Tunable White - T15	12																						
RGBW	??																						
	Citizen																						
	2700																						
	3000																						
	3500																						
	4000																						

All Measurements delivered or derived delivered lumens based on 3000K.

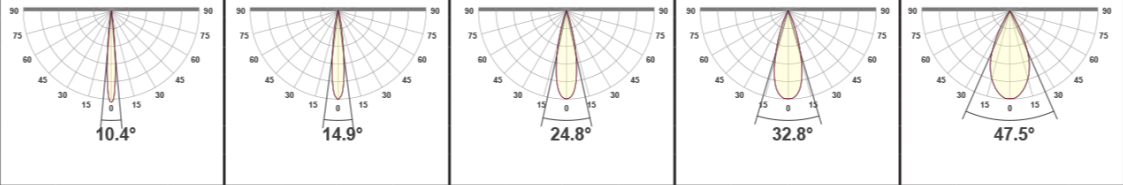

Color Data

All data is based from goniometer measurements of production representative product. All lumen values can vary +/- 10% from LED manufacturer rated data range.

Citizen CoB c6, c8, c10, c14, c20

- <3 MacAdam Ellipse (<3 SDCM)

92 CRI	52 R9
92 RF	100 RG

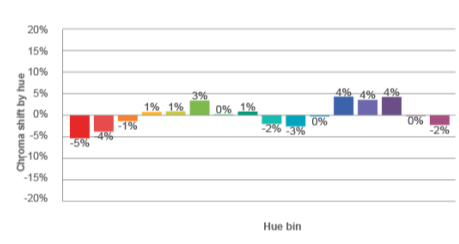
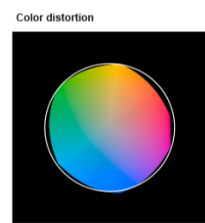
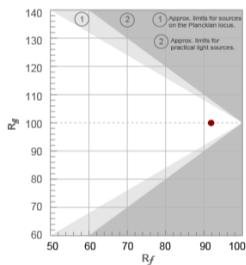
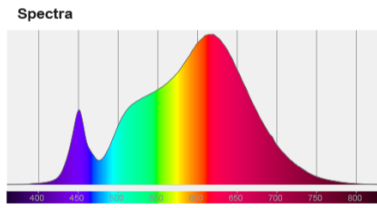
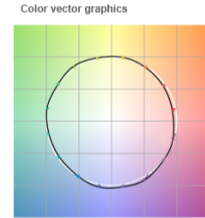
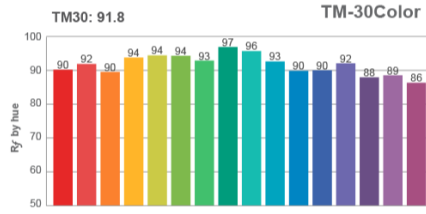
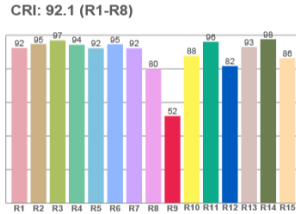

AmbientDim™ A14

- <3 MacAdam Ellipse (<3 SDCM)

3000 CCT Full Output

97 CRI	98 R9	95 RF	104 RG
--------	-------	-------	--------

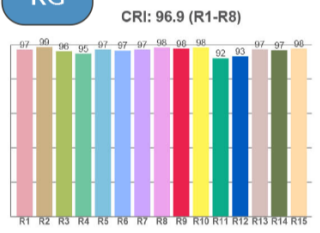
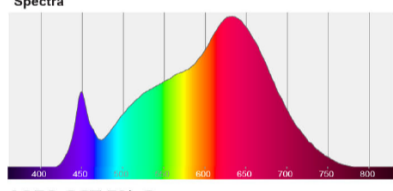

1850 CCT 5% Output

93 CRI	72 R9	83 RF	110 RG
--------	-------	-------	--------

